

**20 COUNT FINGERSLOT WITH LARGE
BRANDED FRONT PANEL. HOLDS (20) SAMPLES
(BLACK) ORDER# 20CFSBLKOSDT1/CTN**

QTY: (1-19) PACKED 1/CTN **\$59.97/EACH**

QTY: (20-50) PACKED 1/CTN **\$53.85/EACH**

QTY: (50 +) PACKED 1/CTN **\$51.99/EACH**

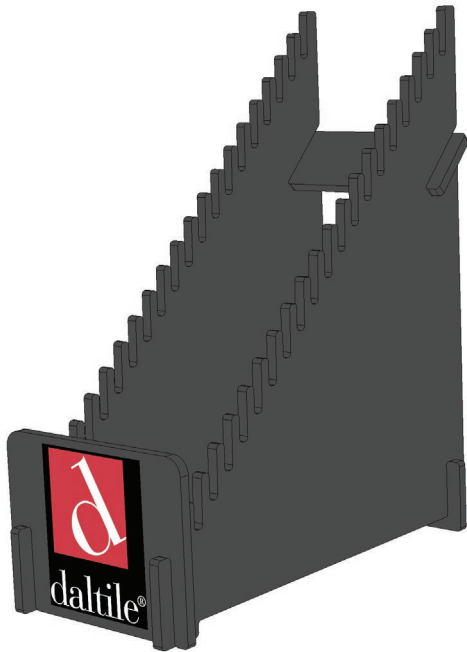

"SLIP TOGETHER"
ASSEMBLY
(NO TOOLS
REQUIRED)

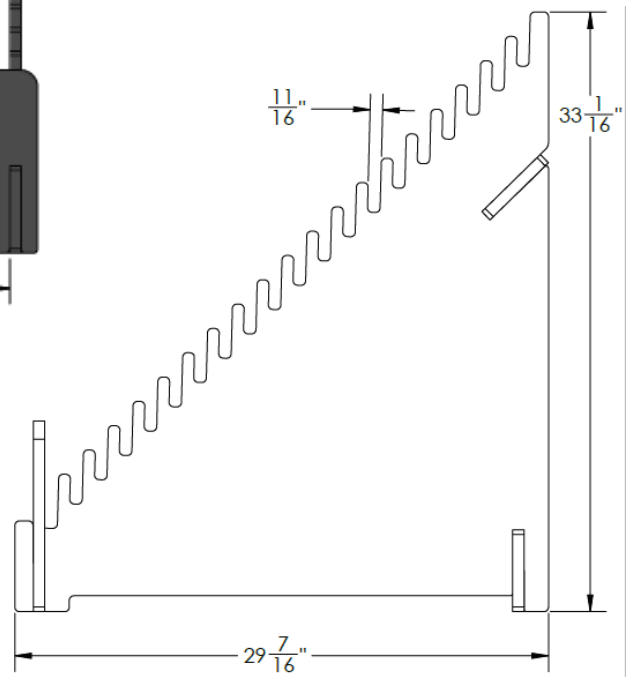
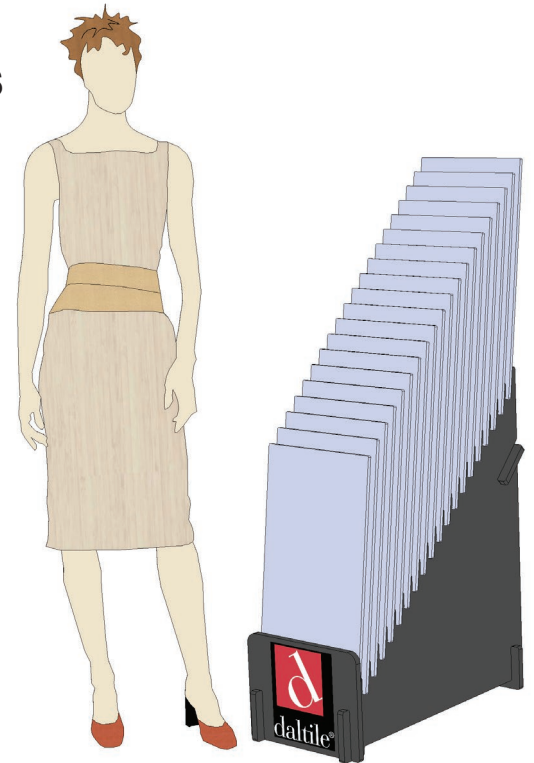
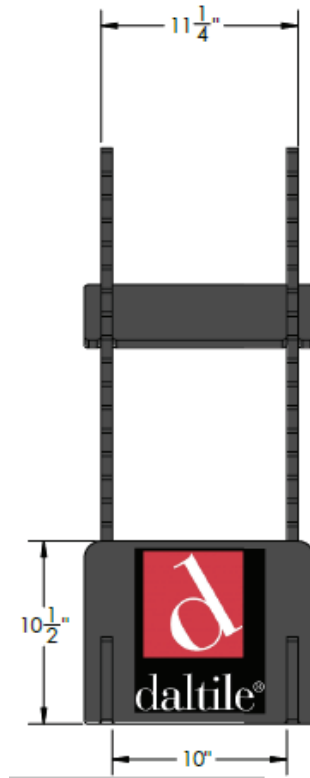

HOLDS 20 SAMPLES
MINIMUM WIDTH 12" WIDTH,
BLACK WITH BLACK PAINTED EDGES
MAXIMUM TILE THICKNESS IS 11/16"
WE CAN MAKE OTHER SIZE SLOTS
FOOTPRINT: 10" WIDE X 29-7/16" DEEP X 33-1/16" TALL
WEIGHT" 26LBS